



■ Features :

- Universal AC input / Full range
- Fully isolated plastic case with IP64 level
- Built-in constant current limiting circuit with adjustable OCP level
- Protections: Short circuit / Overload / Over voltage
- Optional dimming function : 1.1~10VDC (D type) or PWM (P type) controlled
- UL1310 Class 2 power unit
- Cooling by free air convection
- 100% full load burn-in test
- Suitable for LED lighting and moving sign applications
- Low cost
- 2 years warranty

IP64 

SPECIFICATION

MODEL		ELN-30-5	ELN-30-9	ELN-30-12	ELN-30-15	ELN-30-24	ELN-30-27	ELN-30-48	
OUTPUT	DC VOLTAGE	5V	9V	12V	15V	24V	27V	48V	
	LED OPERATION VOLTAGE Note.7	3 ~ 5V	3 ~ 9V	3 ~ 12V	3 ~ 15V	3 ~ 24V	3 ~ 27V	3 ~ 48V	
	RATED CURRENT	5A	3.4A	2.5A	2A	1.25A	1.12A	0.63A	
	CURRENT RANGE	0 ~ 5A	0 ~ 3.4A	0 ~ 2.5A	0 ~ 2A	0 ~ 1.25A	0 ~ 1.12A	0 ~ 0.63A	
	RATED POWER	25W	30.6W	30W	30W	30W	30.24W	30.24W	
	RIPPLE & NOISE (max.) Note.2	80mVp-p	100mVp-p	120mVp-p	120mVp-p	150mVp-p	150mVp-p	250mVp-p	
	VOLTAGE ADJ. RANGE	4.5 ~ 5.5V	8.7 ~ 10.5V	10.8 ~ 13.2V	13.5 ~ 16.5V	21.6 ~ 26.4V	24.3 ~ 29.7V	43.2 ~ 52.8V	
		Can be adjusted by internal potential meter SVR1							
	CURRENT ADJ. RANGE	-25% ~ 3%. Can be adjusted by internal potential meter SVR2							
	VOLTAGE TOLERANCE Note.3	±5.0%							
LINE REGULATION	±1.0%								
LOAD REGULATION	±2.0%								
SETUP, RISE TIME Note.6	500ms, 50ms / 230VAC 1000ms, 50ms / 115VAC at full load								
HOLD UP TIME (Typ.)	50ms/230VAC 16ms/115VAC at full load								
INPUT	VOLTAGE RANGE	90 ~ 264VAC							
	FREQUENCY RANGE	47 ~ 63Hz							
	EFFICIENCY (Typ.)	75%	80%	82%	82%	85%	85%	87%	
	AC CURRENT	0.75A/115VAC 0.48A/230VAC							
	INRUSH CURRENT(max.)	COLD STAR 60A/230VAC							
LEAKAGE CURRENT	0.25mA / 240VAC								
PROTECTION	OVER CURRENT Note.4	95 ~ 110%							
		Protection type : Constant current limiting, recovers automatically after fault condition is removed							
	OVER VOLTAGE	5.75 ~ 6.75V	11 ~ 13.5V	13.8 ~ 16V	17.5 ~ 21V	28 ~ 32V	31 ~ 36.4V	54 ~ 60V	
		Protection type : Shut down o/p voltage, re-power on to recover							
FUNCTION	DIMMING CONTROL (OPTIONAL)	1 ~ 10VDC or PWM							
ENVIRONMENT	WORKING TEMP.	-20 ~ +60°C (Refer to output load derating curve)							
	WORKING HUMIDITY	20 ~ 90% RH non-condensing							
	STORAGE TEMP., HUMIDITY	-40 ~ +80°C, 10 ~ 95% RH							
	TEMP. COEFFICIENT	±0.03%/°C (0 ~ 50°C)							
	VIBRATION	10 ~ 500Hz, 2G 10min./1cycle, period for 60min. each along X, Y, Z axes							
SAFETY & EMC	SAFETY STANDARDS	Design refer to UL1310 Class 2, TUV EN60950-1, CAN/CSA C22.2 No. 223-M91(except for 48V), EN61347-2-13; IP64 approved							
	WITHSTAND VOLTAGE	I/P-O/P:3KVAC							
	ISOLATION RESISTANCE	I/P-O/P:>100M Ohms/500VDC 25°C 70%RH							
	EMI CONDUCTION & RADIATION	Compliance to EN55022 (CISPR22) Class B							
	HARMONIC CURRENT	Compliance to EN61000-3-2,-3							
EMS IMMUNITY	Compliance to EN61000-4-2,3,4,5,6,8,11; ENV50204, EN55024, light industry level, criteria A								
OTHERS	MTBF	628.3Khrs min. MIL-HDBK-217F (25°C)							
	DIMENSION	145*47*30mm (L*W*H)							
	PACKING	0.26Kg; 60pcs/16.6Kg/1.2CUFT							
NOTE	<ol style="list-style-type: none"> 1. All parameters NOT specially mentioned are measured at 230VAC input, rated load and 25°C of ambient temperature. 2. Ripple & noise are measured at 20MHz of bandwidth by using a 12" twisted pair-wire terminated with a 0.1uf & 47uf parallel capacitor. 3. Tolerance : includes set up tolerance, line regulation and load regulation. 4. Derating may be needed under low input voltage. Please check the derating curve for more details. 5. The power supply is considered a component which will be installed a final equipment. The final equipment must be re-confirmed that it still meets EMC directives. 6. Length of set up time is measured at first cold start. Turning ON/OFF the power supply may lead to increase of the set up time. 7. Constant current operation region is within the specified output voltage range above. This is the suitable operation region for LED related applications. 								

Mechanical Specification

Case No.964A Unit:mm

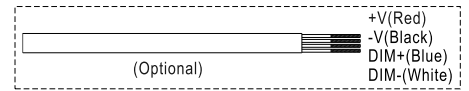
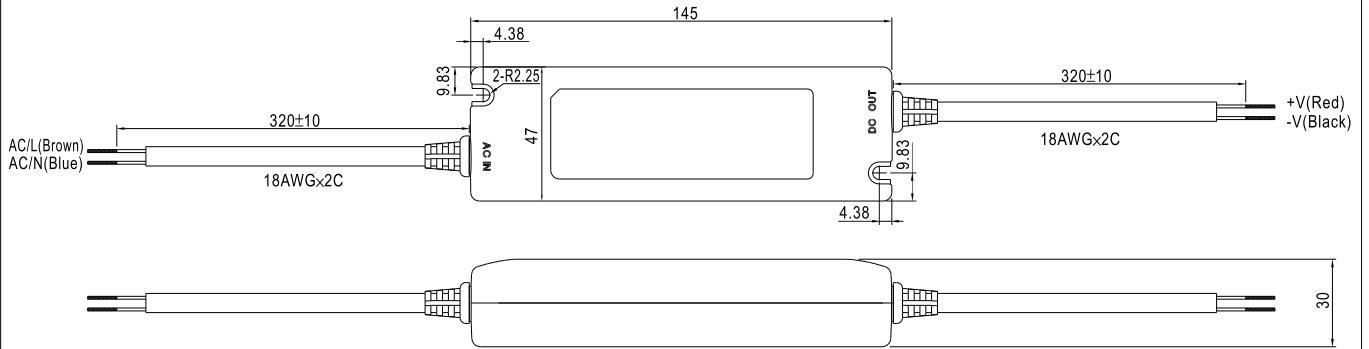

Output voltage and current adjustment : remove the upper case and adjust through SVR1 & SVR2 shown in the diagram.

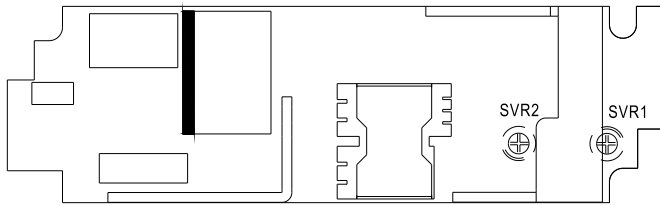

SVR1	Output voltage adjustment
SVR2	Output current adjustment

Block Diagram

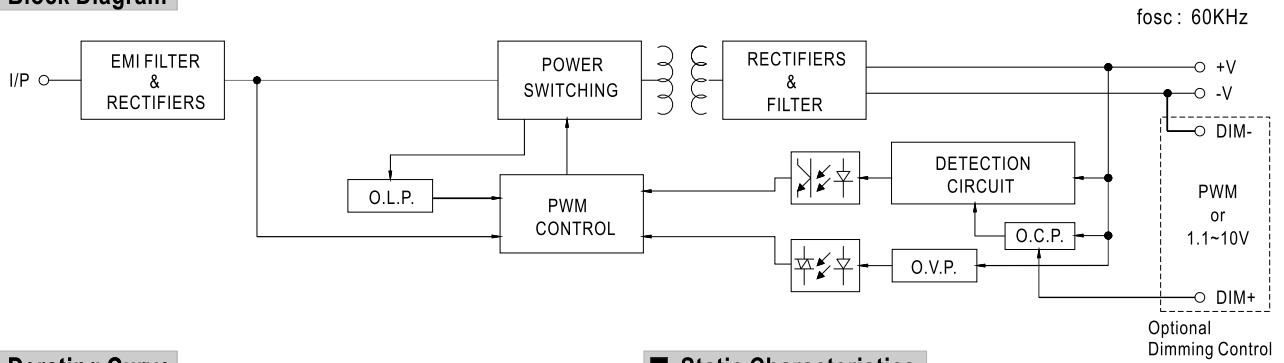

Derating Curve

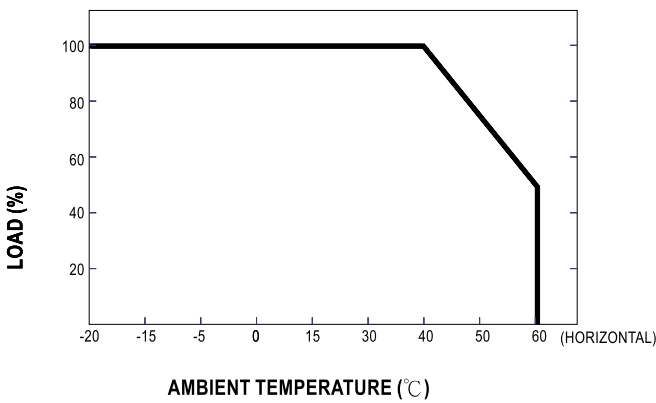

Static Characteristics

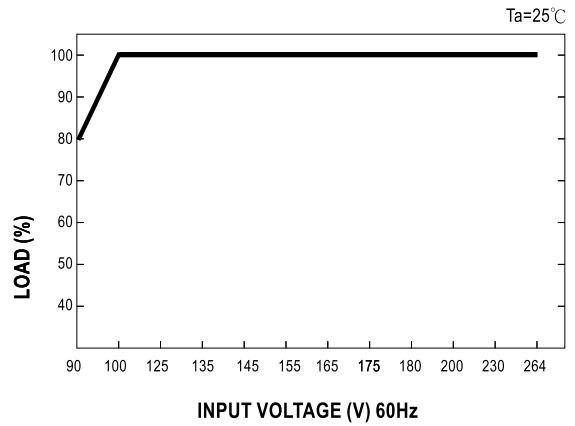

Dimming Control (Optional)

Level of output current can be adjusted through the dimming control function.

(1) 1.1~10V

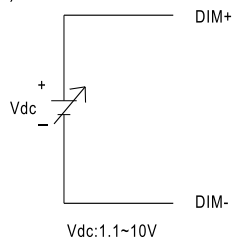

(2) PWM

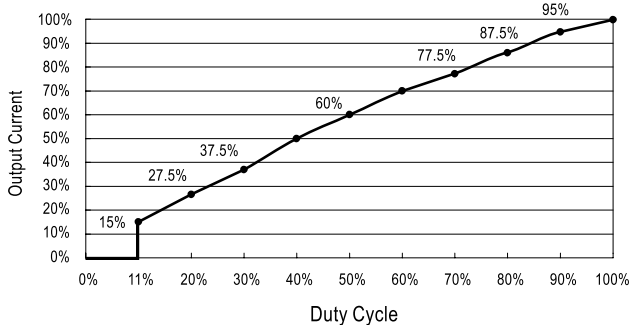
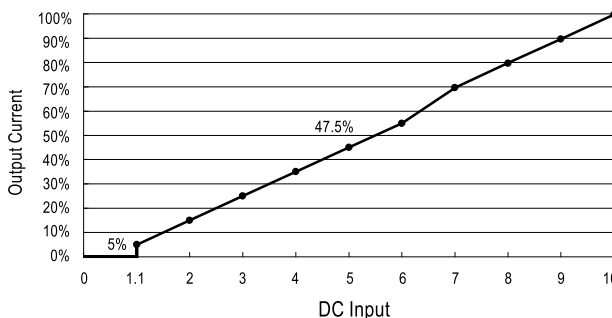
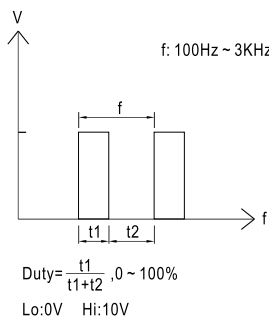

Recommend Application Deployment (24V)

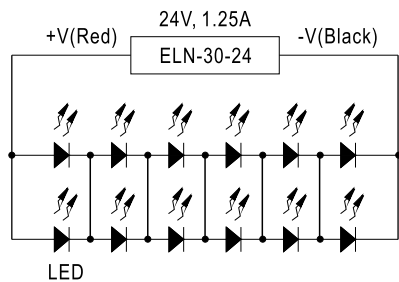

1 to 6 LEDs // 2 strips

This configuration is based on LED with the following parameters :

$V_f = 3.0 \sim 3.5V$ $I_f = 600 \sim 700mA$

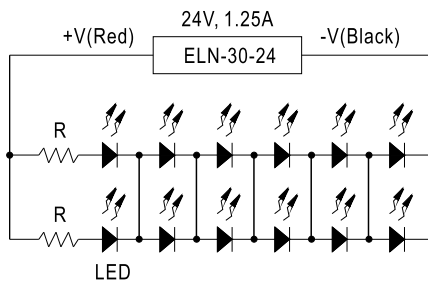

6 LEDs // 1 to 2 strips

This configuration is based on LED with the following parameters :

$V_f = 3.0 \sim 3.5V$ $I_f = 600 \sim 700mA$

$R = 10 \text{ ohm}, 10W$

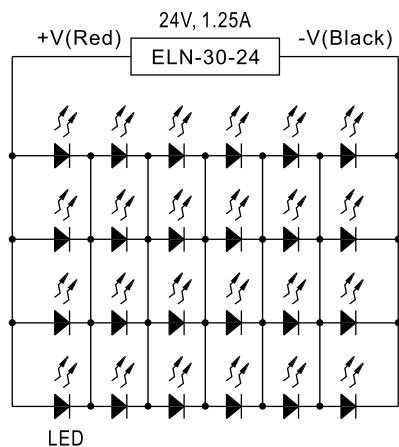

1 to 6 LEDs // 4 strips

This configuration is based on LED with the following parameters :

$V_f = 3.0 \sim 3.5V$ $I_f = 300 \sim 350mA$

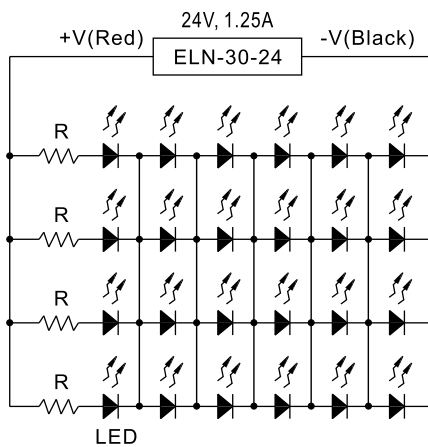

6 LEDs // 1 to 4 strips

This configuration is based on LED with the following parameters :

$V_f = 3.0 \sim 3.5V$ $I_f = 300 \sim 350mA$

$R = 20 \text{ ohm}, 3W$